

Project Identity
Nuvia

C328



NATUZZI
EDITIONS

Project Identity

Natuzzi Editions

The Project Identity purpose is to offer a unique working method that guarantees chromatic and stylistic conformity and preserves the Brand's DNA.

This tool represents a guide that goes beyond the offer of a product, aiming at the creation of a real project from the stores to the customers' homes.

Nuvia

With its rounded forms and spacious volumes, the Nuvia sofa welcomes you as an enveloping embrace - offering ethereal moments of pure well-being. It's like lying on a soft cloud, suspended in the sky. Its functional soul is expressed through the integrated console providing support and space for total comfort. An innovative Triple Motion mechanism enables two exclusive, healthy functions, Zero Gravity and Micromobility. The first allows you to reach a position that makes you feel weightless, with proven health benefits including taking the pressure off your spine and promoting circulation in your legs. The second acts while the user is in a resting position, slowly tilting seat and footrest simultaneously with micro movements that keep muscles active improving blood circulation and contributing to a state of relaxation.



Design by Natuzzi Design Center

In the Natuzzi Headquarter in Puglia, the Design Center preserves the balance between design and functionality, values rooted in the brand's DNA.



Discover our new vision of comfort.
Feelwell combines physical relaxation
and mental balance, offering
a tailor-made wellness experience.

Choose your Nuvia

The Nuvia project is extremely versatile thanks to its 10 SKUs that allow us to create unlimited configurations suitable for any space, from the stores to our customers' homes.

Triple power motion sofa
with micromobility
function

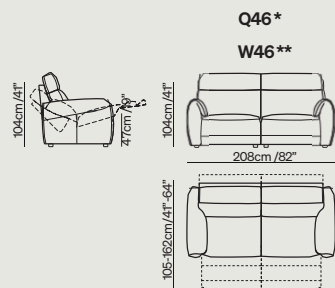

Chair with arm

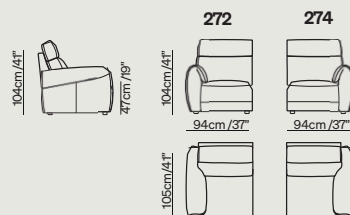

Armless chair

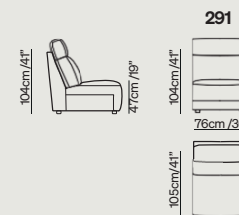

Wedge corner

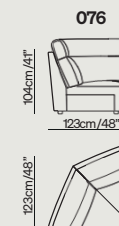

Triple power motion chair with arm
and micromobility
function

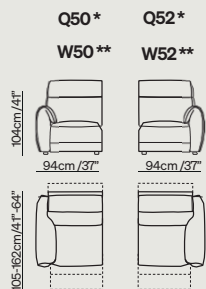

Triple power motion armless
chair and micromobility
function

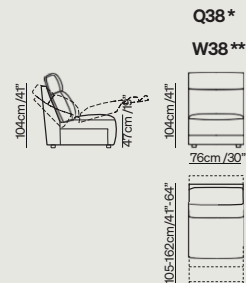

Multifunctional console
with wooden finish

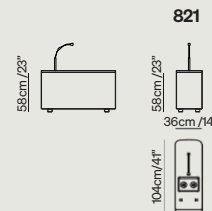

Multifunctional console
with wooden finish

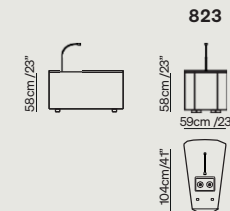

* EU version – with emergency button (in compliance with EU machinery regulation)

** Non EU version – without emergency button

Versatility and configurations

The abacus «Versions and Compositions» shows all the versatility of the project. In particular, as in the examples below:



Q46 *
W46 **

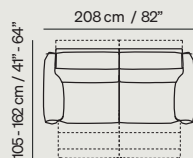

Q50+291+Q52 *
W50+291+W52 **

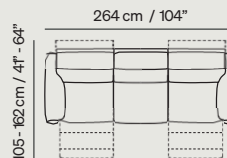

Q50+823+Q38+823+Q52 *
W50+823+W38+823+ W52 **

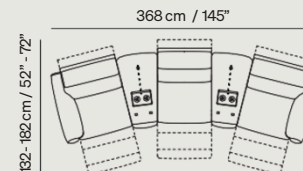

Q50+Q38+076+274 *
W50+W38+076+274 **

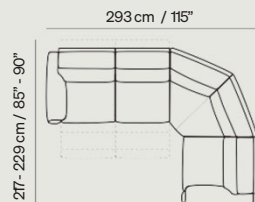

272+076+291+821+Q52 *
272+076+291+821+W52 **

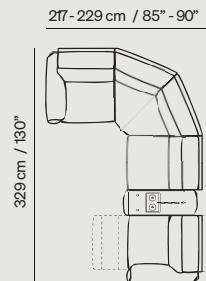

Q50+Q38+076+291+Q52 *
W50+W38+076+291+W52 **

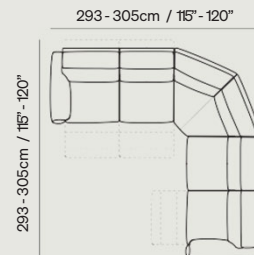

Q50+291+076+Q38+821+Q52 *
W50+291+076+W38+821+W52 **

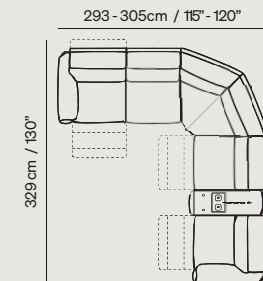

* Configuration including «Q» versions (EU compliant – with emergency button)
** Configuration including «W» versions (non EU – without emergency button)

Thanks to the Configurator, it's possible to customize this versatility according to the customer's needs.

Features & Benefits



Triple Power Motion mechanism



Micro-Mobility



Zero-Gravity



Multiple configurations



Available in Leather and Fabric



Multifunctional console



«Triple Power Motion» Mechanism that individually activates the footrest, headrest, and lumbar support, allowing the seating position to be adjusted for maximum comfort, providing a fully personalized relaxing experience.

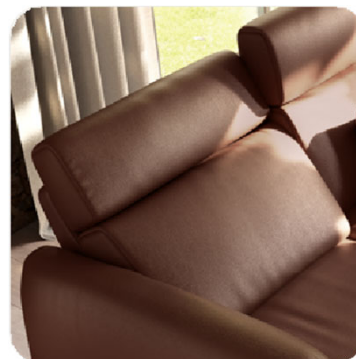

The **«Zero Gravity»** position is achieved through the triple motion function, by fully opening the seat to total body extension, elevating the feet to heart level, while enhancing circulation and providing an optimal relaxation position.



«Micromobility» Starting from the resting position, the sofa moves imperceptibly to keep the body's muscles active. It works by slowly tilting the seat and footrest simultaneously with micromovements that improve blood circulation, contributing to a deeper state of relaxation.



Switch Panel Pocket
A fully upholstered pocket housing the switch panel enhances the visual appeal of the model, offering a distinctive aesthetic element.



The **multifunctional console**, with a full wooden finish, features a spacious tabletop, a storage drawer, a built-in USB port, and connectors for adding optional features—blending style, convenience, and versatility.
Available in the following wooden finishes:
Ash Brown (49) and Ash Blonde (50)

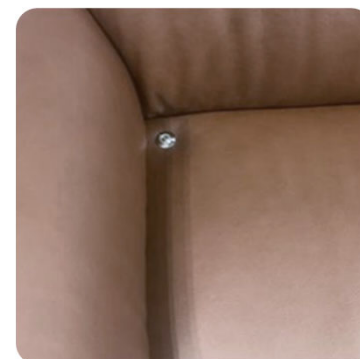

Emergency Button
(only on «Q» versions – EU compliant)
Positioned on the interior side of the seating, the emergency button must remain deactivated (led off) to enable all powered motion features, including micromobility. Engaging this button (led on) will instantly halt all operations. Power functions will remain disabled until the button is pressed again (led off) to reactivate them.



Scan to discover more about Micromobility, Triple Power Motion and Zero-Gravity.

Micromobility & Zero-Gravity Features & Benefits

Sink into a new era of comfort with our exclusive Micromobility technology, designed to keep your body in gentle, continuous motion—effortlessly enhancing posture, reducing muscle tension, and boosting circulation. Inspired by the natural flow of movement, this innovative system supports your well-being while you sit. Paired with Zero-Gravity seating, it cradles your body's natural curves, offering full back support and deep relaxation. Whether reading, meditating, or unwinding, experience effortless comfort that promotes better breathing, improved blood flow, and a sense of total weightlessness. Transform every moment of rest into a revitalizing escape.

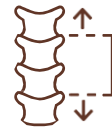

**Reduces pressure
on the spinal column**



**Improves blood flow
and circulation**



Reduces emotional stress

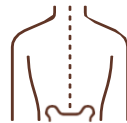

Promotes proper posture



Reduces muscle tension

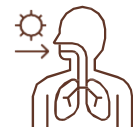

**Improves lung
function over time**

Triple-Motion Technology

Experience customized comfort like never before. With Triple Motion, control the headrest, lumbar, and footrest independently, tailoring your comfort to your exact needs. Adjust the headrest for better neck support, align the lumbar cushion to release daily stress, or activate the footrest to achieve a weightless feel.



Head Support Designed for Your Perfect Escape

Effortlessly adjust the headrest to find your ideal position for watching, reading, or unwinding. Experience tailored comfort that cradles your head and neck, making every moment of relaxation truly rejuvenating.



Customized Lumbar Support for Ultimate Comfort

Effortlessly adjust lumbar pressure to match your posture, reducing back strain and enhancing relaxation. Enjoy personalized support that relieves tension and promotes lasting comfort.



Effortless Relaxation, Space-Saving Comfort

Extend your comfort with a fully adjustable footrest that transforms your seat into a chaise lounge—without taking up extra space. Customize your perfect recline and enjoy a deeply relaxing experience, tailored just for you.

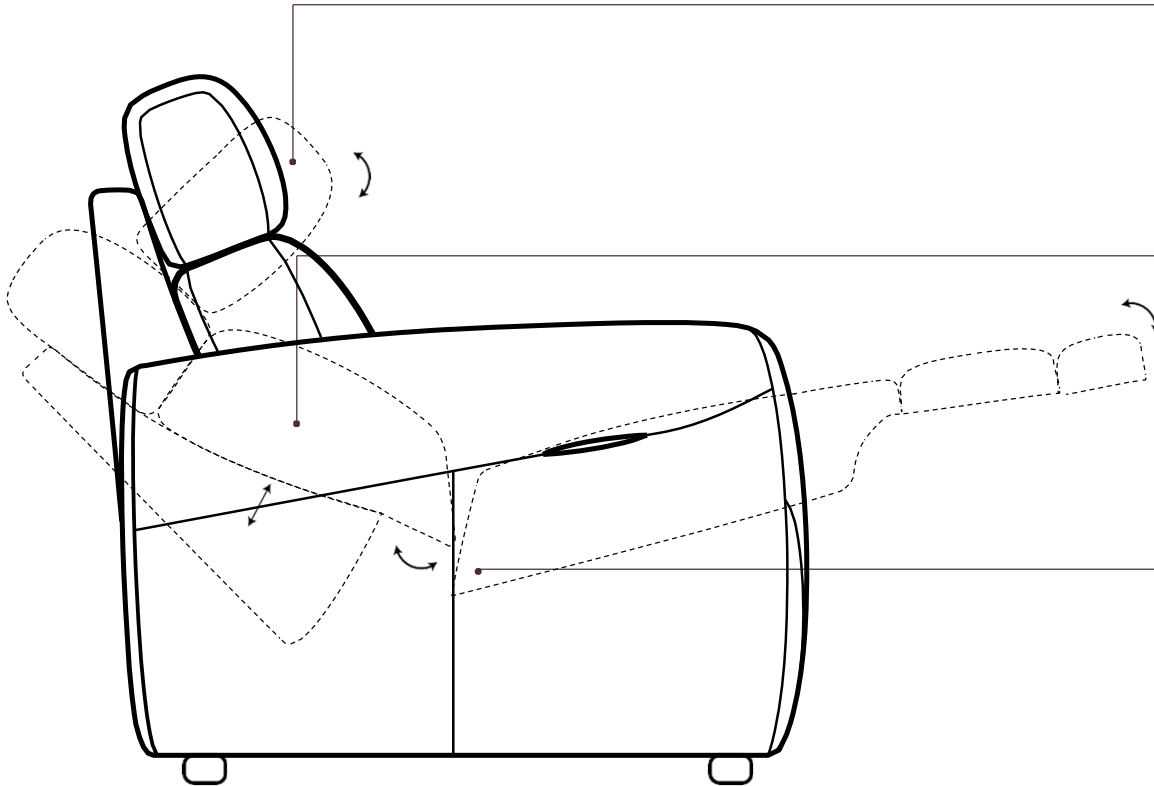

Comfort & Visual Softness

The model features an integrated relax mechanism, which enhances comfort by allowing the seat position to be adjusted according to the desired level of relaxation. Due to the presence of soft padding, slight misalignments between seat sections may occur a physiological behavior resulting from the natural elasticity of the materials, and a sign of genuine comfort and softness.



The soft padding beneath the seat and back cushions adds a "soft-to-the-eye" appearance, conveying a sense of comfort and relaxed hospitality. This construction approach gives the sofa a warmer, more informal, and naturally "lived-in" look.



The integrated mechanism is designed to enhance comfort, allowing the seating position to be adjusted for a personalized sense of comfort. Each sofa is crafted with meticulous attention to detail, showcasing artisanal precision in every stitch and finish. Natural variations such as wrinkles or subtle marks are not flaws but distinctive traits of genuine leather, that highlight the evolving beauty of each piece over time.

Multifunctional Console Features

Available in 2 different configurations:

821

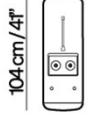
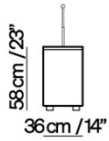

Rectangular

823

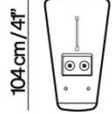
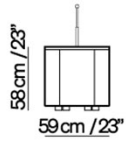

Wedge

Available in 2 different finishings:



49
Ash Brown



50
Ash Blonde

Flexible reading lamp offering
two levels of brightness intensity

A docking station featuring two wireless
charging pads that can easily convert into
cup holders. Also equipped with both USB
Type-A and Type-C ports.

The flexible reading lamp and tabletops
can be detached and repositioned
interchangeably.



Two tabletops with hidden and rotating cup holder



Spacious push and pull storage drawer

Layout examples

It's possible to highlight the versatility of the project even with different layouts, suggesting the creation of various roomsets to show the optimization of spaces in any living area.

DIM: 13,5sqm / 145 sq ft

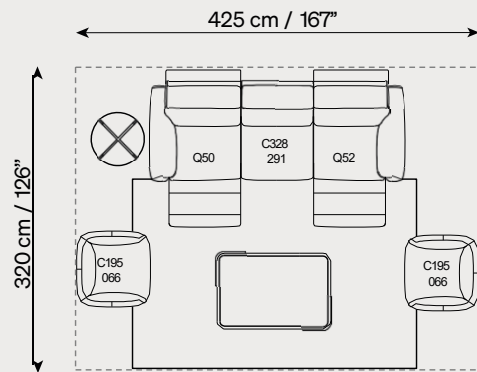

DIM: 15sqm / 161sq ft

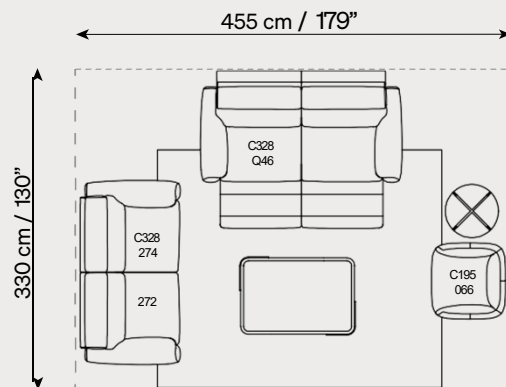

DIM: 16,5sqm / 178 sq ft

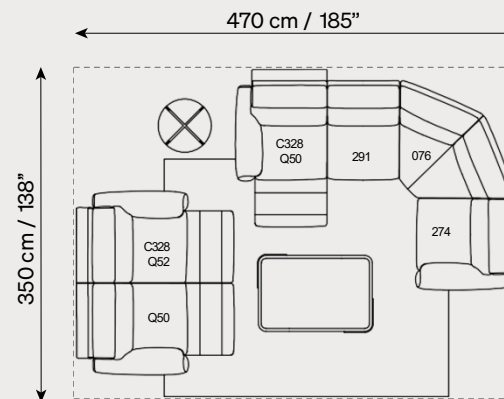

DIM: 20 sqm / 215 sq ft

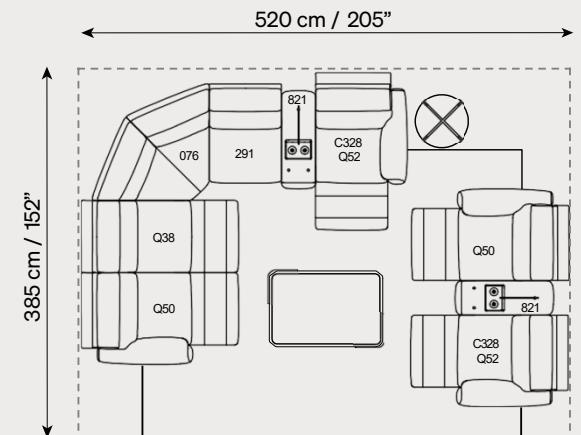

Moodboard earth tone

The Natuzzi Style Center carefully selects materials and coverings, putting them in dialogue with each other. In this case, the Dream leather in the Rawhide color was paired with the Terme velvet in the Rust color. The combination of these coverings together with the wood, will give rise to the moodboard that will create the final total look of the project. Each model in the collection is presented with multiple moodboards to adapt to homes all over the world.



Moodboard earth tone

Together with the moodboard of coverings and materials, the Style Centre harmonizes the sofa with furniture and accessories to complete the interior design project.

Q50+291+076+Q38+821+Q52 (EU)
W50+291+076+W38+821+W52 (Non EU)

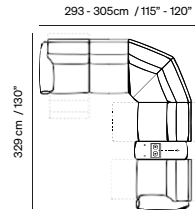

Sofa Sectional: Nuvia C328
Console Finish: 49 Ash Brown

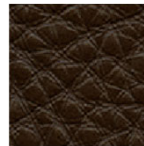

DREAM 20JQ

Q46 (EU)
W46 (Non EU)

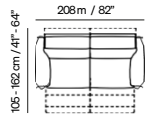

Sofa: Nuvia C328

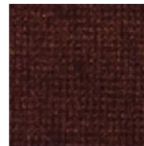

TERME
78.0184.09

066

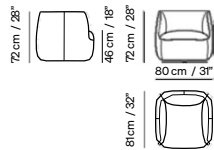

Occasional Chair: Wally C195
with swivel base

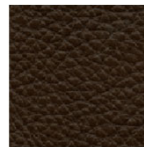

DREAM 20JQ

376

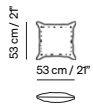

385

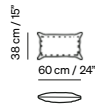

Pillow: A800

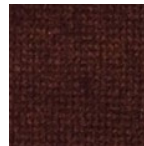

TERME
78.0184.09

These products have been carefully selected to maintain the atmosphere of the design. Therefore, while the sofa configurations can be changed to fit the space and personal needs, the combination of colors, materials and finishes cannot be altered.



Central Table: Gate
120cm/47" X 80cm/31" H38cm/15"
Ash Brown / Matt Amarone
Q186011XOF



Side Table: Wire
D56cm/22" H50cm/20"
Ash Brown
T042004XOF



Decorative Objects:
Vases Roman D30cm/12" x H41cm/16"
D25,5cm/10" x H37cm/14" Rust
O973001XOF
Tray Greek 3pcs
O064003XOF



Rug: Whisper
300cm/118" X 400cm/157"
Pale Rose
V823043XOF

Moodboard blue

The Natuzzi Style Center carefully selects materials and coverings, putting them in dialogue with each other. In this case, the Madison leather in the Blue Night color was paired with the Cupido fabric in the Midnight Blue color. The combination of these coverings together with the ceramic & wood, will give rise to the moodboard that will create the final total look of the project. Each model in the collection is presented with multiple moodboards to adapt to homes all over the world.



Moodboard blue

Together with the moodboard of coverings and materials, the Style Centre harmonizes the sofa with furniture and accessories to complete the interior design project.

Q50+291+076+Q38+821+Q52 (EU)
W50+291+076+W38+821+W52 (Non EU)

293 - 305cm / 115" - 120"

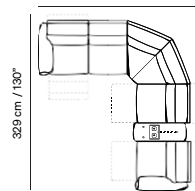

Sofa Sectional: Nuvia C328
Console Finish: 49 Ash Brown

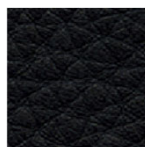

MADISON 20RG

Q46 (EU)
W46 (Non EU)

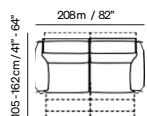

Sofa: Nuvia C328



CUPIDO
78.0779.06

066

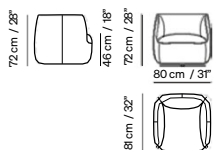

Occasional Chair: Wally C195
with swivel base



CUPIDO
78.0779.06

376

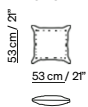

385

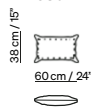

Pillow: A800

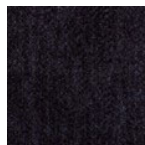

CUPIDO
78.0779.06

376

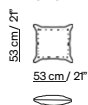

385

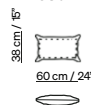

Pillow: A800

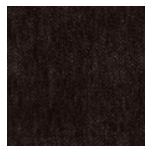

CUPIDO
78.0779.07

These products have been carefully selected to maintain the atmosphere of the design. Therefore, while the sofa configurations can be changed to fit the space and personal needs, the combination of colors, materials and finishes cannot be altered.



Central Table: Como
90cm/35" x 90cm/35" x H35cm/14"
Ceramic Statuario/Ash Brown/Champagne
Q832001XOF



Side Table: Como
50cm/19" x 40cm/15" x H52cm/20"
Ceramic Statuario/Ash Brown/Champagne
Q832005XOF



Decorative Objects:
Luster Vase D19,5cm/7,5" x H34cm/13"
O979001XOF
Luster Vase 24,5cm/9,5" x H38cm/15"
O979004XOF

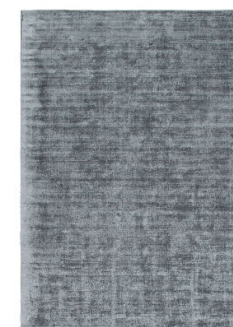

Rug: Whisper
300cm/118" x 250cm/98"
Light Ottanio
V823030XOF

Moodboard earth tone

The Natuzzi Style Center carefully selects materials and coverings, putting them in dialogue with each other. In this case, the Le Mans leather in the Light Tan color was paired with the Brezza velvet in the Beige color. The combination of these coverings together with the ceramic & wood, will give rise to the moodboard that will create the final total look of the project. Each model in the collection is presented with multiple moodboards to adapt to homes all over the world.



Moodboard earth tone

Together with the moodboard of coverings and materials, the Style Centre harmonizes the sofa with furniture and accessories to complete the interior design project.

272+076+291+821+Q52 (EU)
272+076+291+821+W52 (Non EU)

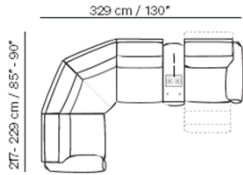

Sofa Sectional: Nuvia C328
Console Finish: 50 Ash Blonde

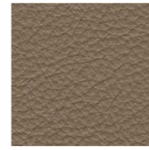

15F5 LE MANS

Q46 (EU)
W46 (Non EU)

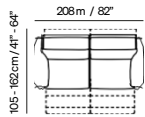

Sofa: Nuvia C328



70.0077.22
BREZZA

066

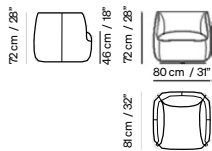

Occasional Chair: Wally C195
with swivel base



78.0188.04
REMO

376

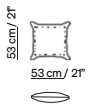

385

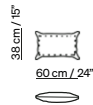

Pillow: A800



78.0188.04
REMO



Central Table: Gate
120cm/47" X 80cm/31" H38cm/15"
Ash Blonde/Matt Beige
Q186012XOF



Rug: Whisper
300cm/118" x 250cm/98"
Dark Sand
V823046XOF

These products have been carefully selected to maintain the atmosphere of the design. Therefore, while the sofa configurations can be changed to fit the space and personal needs, the combination of colors, materials and finishes cannot be altered.

NATUZZI
EDITIONS