

Brig project

L023



NATUZZI
ITALIA

Harmony project

Natuzzi Italia

The Harmony Project aims to offer a unified working method that ensures chromatic and stylistic harmony, preserving the brand's DNA.

This tool is intended to be more than just a product offering, aiming to harmonize an entire interior design project.

Briq

The Briq project combines comfort, craftsmanship, versatility, and functionality, highlighted by the bed storage with a double movement mechanism, which makes access to all areas of the bed easy. Available in four sizes, both in leather and fabric, it is designed to meet every space requirement.



Design by Claudio Bellini

Claudio Bellini is an architect, designer, and art director. In 1996, he founded his studio in Milan. His approach to design, attentive to the needs of a growing global market, is based on the centrality of harmony, beauty, and efficiency.



Choose your Briq

The Briq project is highly versatile, with the bed available in different sizes to accommodate various spaces. Additionally, the Briq bed is offered with an optional bedding box feature, enhancing its functionality and adaptability to different needs.

Bed with slate frame

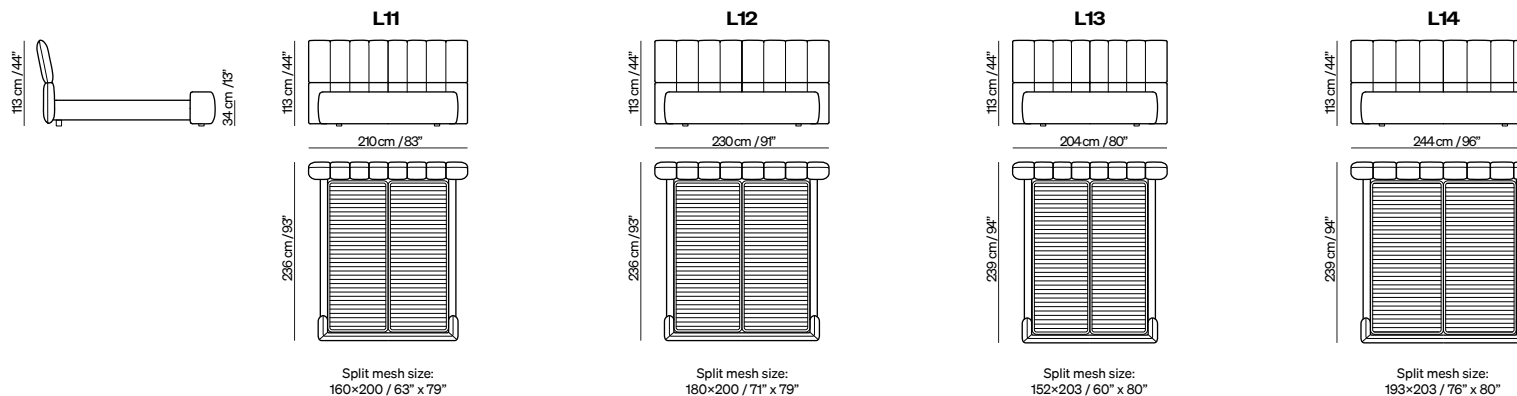

Bed with slate frame and liftable bedding box mechanism

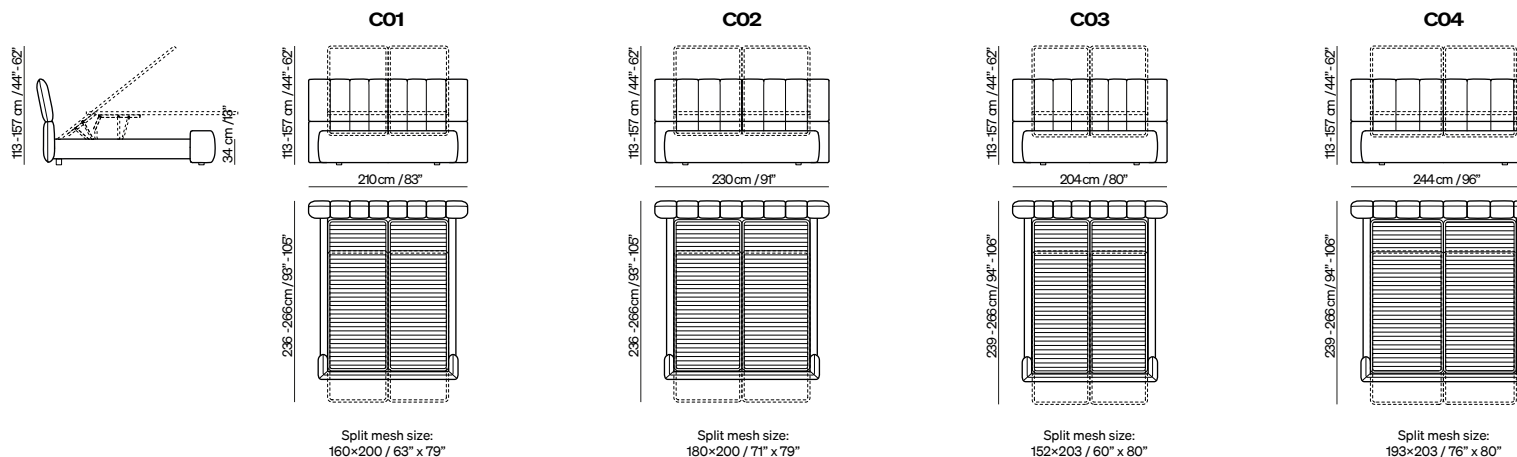

Technical features

The BRIQ bed's essential design strikes a perfect balance with its generously padded headboard, adorned with dynamic vertical seams. Fully upholstered and finished on the back, it can be positioned anywhere in the room. Its functionality shines with an optional hidden storage, making it easy to store all your bed essentials.

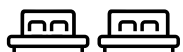

King and Queen Sizes



Leather and Fabric



Closed Base Storage

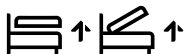

Lift System With Two Opening Options



The lift-up system has two positions: 45-degree and horizontal (70 cm above ground). It facilitates bed-making and access to storage near the headboard. The gas piston mechanism ensures smooth operation, and the epoxy-coated steel frame offers durability and resistance to chemicals, corrosion, and shocks.



The hidden metal feet provide a sleek appearance and enhanced stability, while the closed base frame offers a clean, modern look.



The leather handle allows for effortless opening and closing of the storage, while the orthopedic solid beech wood slats provide optimal support during sleep.

Layout Examples

You can also showcase the versatility of the project with different layouts, highlighting the creation of various configurations to optimize space in any bedroom. The bed comes in various frame options to accommodate different mattress dimensions, providing flexibility to fit a range of bedroom layouts and needs.

DIM: 18 SQM / 193 SQ FT

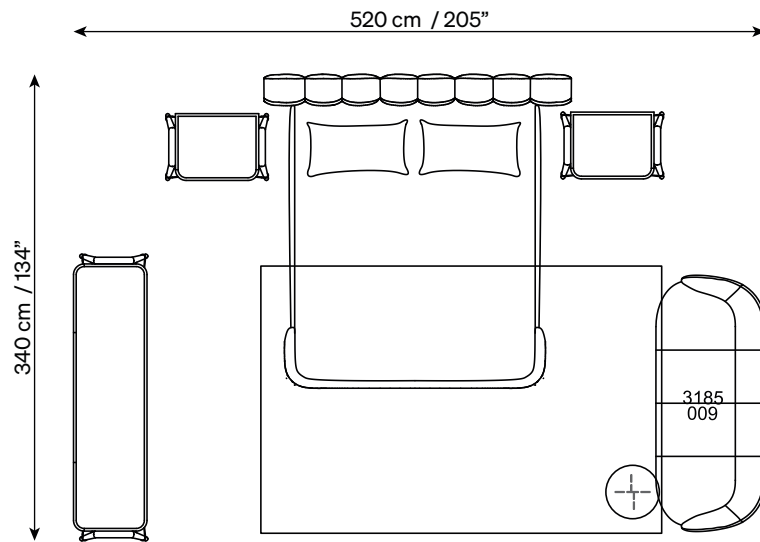

DIM: 16 SQM / 172 SQ FT

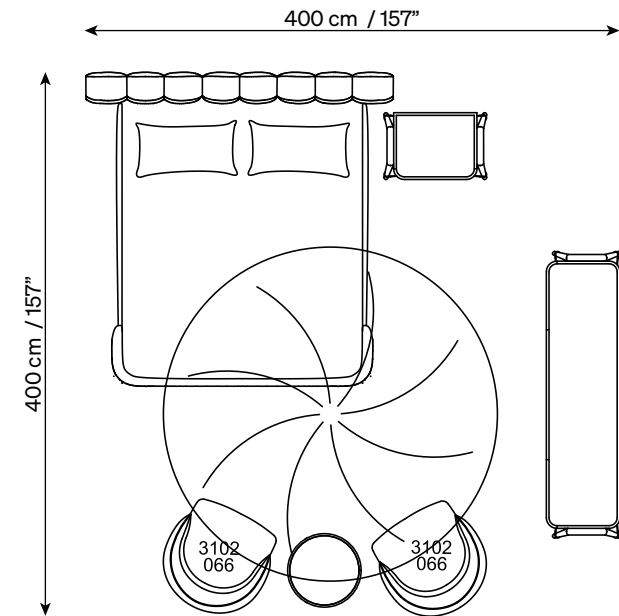

Moodboard warm neutral 1

To bring harmony to the projects, the Natuzzi Style Center carefully selects materials and coverings, creating a dialogue between them. In this case, the Stromboli Leather in Nude colour has been paired with Montemario Fabric in Sand colour. The harmonization of these coverings with woods and marbles will give rise to the moodboard that will define the final total look of the project. Each collection model is presented with multiple moodboards to suit all market geographies.



Moodboard warm neutral 1

Along with the moodboard of coverings and materials, the Natuzzi Style Center harmonizes the bedroom with furniture and accessories to complete the interior design project.

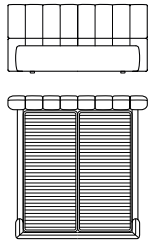

bed: Briq L023



30IV STROMBOLI



Bedside Table: Venera
50×50 H56 Walnut/Black Glossy



Accent Table: Ido 40×40 H47
Calacatta Gold Marble
T157XYT

066

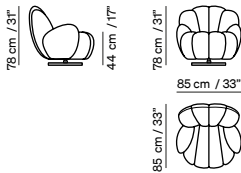

occasional chair: Seashell 3256



MONTEMARIO
88.0092.02



Rug: Sophia B
300×400 Beige
V843029XNA

These products have been carefully selected to maintain the atmosphere and harmony of the design.
While the bed frame is available in different sizes to suit various spaces and needs,
the combination of colors, materials, and finishes remains fixed and cannot be altered.

Moodboard warm neutral 2

To bring harmony to the projects, the Natuzzi Style Center carefully selects materials and coverings, creating a dialogue between them. In this case, the Status Leather in White colour has been paired with Botteghe Fabric in Gold colour, together with Piazzadispagna Fabric in Gold colour. The harmonization of these coverings with woods and marbles will give rise to the moodboard that will define the final total look of the project. Each collection model is presented with multiple moodboards to suit all market geographies.



Moodboard warm neutral 2

Along with the moodboard of coverings and materials, the Natuzzi Style Center harmonizes the bedroom with furniture and accessories to complete the interior design project.

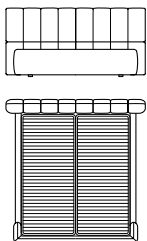

bed: Briq L023

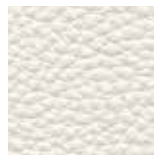

STATUS 2542



Sideboard: Svevo
55x200 H77 Smoked Oak
B00701X



Bedside Table: Svevo
48x78 H50 Smoked Oak
B00702X

066

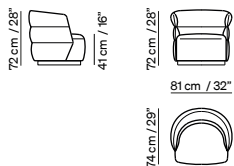

occasional chair: couture 3102



BOTTEGHE
83.0115.09



Accent Table: Icon
55x55 H56 Smoked Oak/Brass
E03211X

066

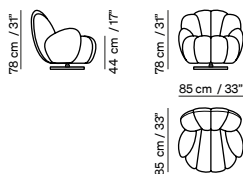

occasional chair: Seashell 3256

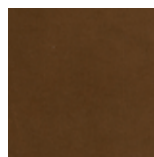

PIAZZADISPAGNA
86.0065.01



Bookcase: Radice
Composition customizable



Rug: Vortex
350x350 Gold V855004XNA

These products have been carefully selected to maintain the atmosphere and harmony of the design. While the bed frame is available in different sizes to suit various spaces and needs, the combination of colors, materials, and finishes remains fixed and cannot be altered.

Moodboard warm neutral 3

To bring harmony to the projects, the Natuzzi Style Center carefully selects materials and coverings, creating a dialogue between them. In this case, the Status Leather in Light Grey colour has been paired with Rizzoli Fabric in Mink colour, together with Galleria Fabric in Platinum colour. The harmonization of these coverings with woods and marbles will give rise to the moodboard that will define the final total look of the project. Each collection model is presented with multiple moodboards to suit all market geographies.



Moodboard warm neutral 3

These products have been carefully selected to maintain the atmosphere and harmony of the design. While the bed frame is available in different sizes to suit various spaces and needs, the combination of colors, materials, and finishes remains fixed and cannot be altered.

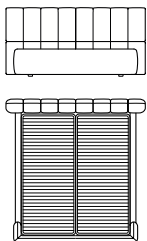

bed: Briq L023
feet finish: FT77 glossy chrome

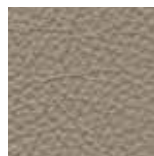

STATUS 2507



Sideboard: Svevo
55x200 H77 Smoked Oak
B00701X



Bedside Table: Svevo
48x78 H50 Smoked Oak
B00702X

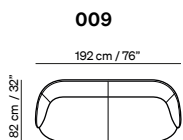

sofa: botanic 3185



RIZZOLI
70.0085.14



Accent Table: Estro
50x50 H55 Invisible Gray E02804X

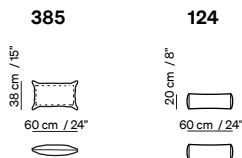

pillows: 2X1800



RIZZOLI 70.0085.14
GALLERIA 99.0030.01



Bookcase: Radice
Composition customizable



Rug: Vortex
350x350 Platinum V855003XNA

These products have been carefully selected to maintain the atmosphere and harmony of the design. While the bed frame is available in different sizes to suit various spaces and needs, the combination of colors, materials, and finishes remains fixed and cannot be altered.

Bedroom furnishing Svevo

designer Manzoni & Tapinassi - Discover the Svevo collection, where design meets art. With rounded, enveloping shapes and a refined mix of materials, each piece blends harmoniously, transforming your home into a space of elegance and comfort. Experience the beauty and functionality of Svevo, designed to create a welcoming and sophisticated environment.

Elegance and Refinement:

The solid ash wood legs, stained in various finishes with steel inserts, add a touch of class and distinction, elevating the appearance of any environment.

Variety of Colors:

The availability of different colors for the wooden parts allows for customization that adapts to various styles of decor.

Consistent Design:

The satin lacquered glass top in the same color as the structure ensures a uniform and harmonious look, ideal for those seeking aesthetic coherence.

High-Quality Materials:

The use of premium materials such as solid wood and satin glass ensures durability and an impeccable appearance.

Versatility:

The intelligent mix of materials makes this night collection, which includes nightstands and a large dresser (6 drawers), suitable for various living contexts.

Made in Italy Collection

Bedside Table

78cm/30,71" x 48cm/18,9" H 50cm/H 19,69"



Smoked Oak/
Coffee Glass/
Brass Metal
B00702X

Chest of Drawers

200cm/78,74" x 55 cm/21,65" H 77cm/H 30,31"



Smoked Oak/
Coffee Glass/
Brass Metal
B00701X

Bedroom furnishing Venere

designer Bernhardt & Vella - The accessories for the night area of the Venere collection are distinguished by a delicate and sinuous structural design, which conveys a sense of lightness and sophisticated elegance. This collection represents a perfect balance between natural beauty and industrial modernity, offering pieces that enrich the environment with a touch of refinement and contemporary style.

Elegant and Modern Design

The structure is made of curved sheet metal, laser-cut with a glossy and painted finish, ensuring robustness and an elegant appearance. The dresser and front panels are available in curved plywood with a combination of predefined colors in glossy lacquer or wood, offering aesthetic versatility.

Hidden Details and Practical Organization

The dresser includes a jewelry compartment, ideal for organizing daily accessories. The drawer interiors are lacquered in the same color as the external finish, for a consistent and refined look.

Ease of Use

Push-pull opening mechanism for easy use without visible handles.

Quality and Durability

High-quality materials and robust construction ensure long-lasting durability.

Made in Italy Collection

Bedside Table

D 50cm/D 19,69" H 56cm/H 22,05"



Glossy Jade
Lacquered/
Brass Metal
B00903X



Glossy White
Chalk Lacquered/
Black Chrome Metal
B00904X



Smoked Oak/
Brass Metal
B00906X



Walnut/
Black Chrome Metal
B00905X

Chest of Drawers

150cm/59,08" x 55 cm/21,65" H 77cm/30,31"



Smoked Oak/
Brass
B00901X



Walnut/
Black Chrome Metal
B00902X



NATUZZI
ITALIA